



Closet and Specialty Hardware

Door & Mirror Hardware	108	Closet Rods	120
Magnetic and Bullet Catches	108	660 Series Heavy-Duty Round Closet Rods	120
Sliding Door Pulls	108	750 Series Heavy-Duty Round Closet Rods	120
Mirror Clips/Glass Clips, Fittings and Latches	109	770 Series Extra-Duty Round Closet Rods	120
		Round Closet Rod Mounting Flanges and Accessories	121
Drawer Accessories	110	880 Series Extra-Duty Oval Closet Rods	122
Index Followers	110	Adjustable Closet Rods	123
Label Holders	110	Closet Brackets	124
Locks	110	1180 Series Closet Shelf Brackets	124
Pulls	110	1190 Series Closet Rods and Shelf Brackets	125
Cabinet Hardware	111	Closet Storage Aids	127
Fasteners	111	Utility Hooks	127
Hinges	111	Coat and Hat Hook	127
Sliding Door Hardware	112	Hang Rod	128
Glass Door Locks	112	Clothing Carrier	128
Door Rollers	112	Towel Bar	128
Sheaves	113		
Fiber Track and Guides	114		
Plastic Tracks and Guides	115		
Plastic Door Track Packaged Assemblies	116		
Steel Tracks and Guides	117		
Roll-Ezy Ball-Bearing Track Systems	118		
Roll-Ezy Aluminum Track Systems	119		

Magnetic and Bullet Catches

Magnetic Catches

918 ALUM Heavy-Duty Aluminum Magnetic Catch

Size: 2-1/16" width x 1" depth x 3/4" tall

Finish: Aluminum (ALUM)

Packed: 10 per carton, packed in a clear envelope with screws

Pull Strength: 7 lbs.



Bullet Catches

901 BR DIP Varnish-Proof Steel Catch with Barrel and Spring

Size: 3/8" diameter, 1/2" long,
5/8" diameter strike

Finish: Brass-look (BR)

Packed: 100 per carton



902 BR DIP Steel Catch with Barrel and Spring

Size: 21/64" diameter, 3/8" long,
5/8" diameter strike

Finish: Brass-look (BR)

Packed: 100 per carton



903 BR DIP Adjustable Brass Catch

Size: 3/8" diameter; 5/8" long;
9/16" x 1-1/16" diameter strike

Finish: Brass-look (BR)

Packed: 100 per carton

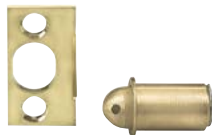

905 BR DIP Adjustable Brass-look Catch

Size: 1/2" diameter; 1-1/32" long;
5/8" x 1-1/4" diameter strike

Finish: Brass-look (BR)

Packed: 50 per carton with screws



Sliding Door Pulls

Knob Pulls

813 ANO Oval Flush Finger Pull*

Size: Over-flange 3/16" x 2-7/8"

Bore 51/64" x 2-1/2" x 25/64" deep

Finish: Anochrome (ANO)

Origin: Made in the USA

Packed: 100 per carton



1088 ANOD Knob Pull

Finish: Zinc plated steel (ANOD)

Packed: Sets of: 2 knobs, screws,
and rubber bumpers per envelope
50 sets per carton

Features: Mounts to 1095 shoe (1092 assembly)



Finger Pulls

801X BR, 801X NP, 803X BR and 803X NP Flush Finger Pull

Size: 801X: 31/32" outside diameter,
Bore 25/36" hole diameter, 1/4" depth
803X: 31/32" outside diameter,
Bore 25/36" hole diameter, 3/8" depth

Finish: Nickel Plate (NP), Brass-look (BR)

Origin: Made in the USA

Packed: 100 per carton



806 ANO Flush Finger Pull*

Size: 2-1/16" outside diameter

Bore 1-3/4" hole diameter, 13/32" depth

Finish: Anochrome (ANO)

Origin: Made in the USA

Packed: 10 per carton



836 ANO Threaded Finger Pull

Size: 1-1/16" outside diameter, cut a 13/16" diameter hole
for installation

Finish: Anochrome (ANO)

Origin: Made in the USA

Packed: 50 per carton

Features: Two-piece screw-together pull for glass 3/16"
to 5/16" thick; with beveled edges



Mirror Clips/Glass Clips, Fittings and Latches

Mirror Clips/Glass Clips

6092 PLAS and PK6092 Plastic Mirror Clips

Size: For 1/4" thick glass/mirror
Finish: Clear Plastic (PLAS)
Packed: 6092: 100 per carton with screws
 PK6092 PLAS: 6 per poly bag with screws; 24 bags per carton



6094 PLAS Plastic Mirror Clip

Size: For 1/8" thick glass/mirror
Finish: Clear Plastic (PLAS)
Packed: 100 per carton with screws



6875 PLAS Plastic Star Mirror Clip

Size: 1-1/8" diameter
Finish: Clear Plastic (PLAS)
Packed: 100 per carton with screws



266 CHR Cast Mirror Clip

Size: 1-1/16" long x 3/4" wide, for 1/4" thick glass/mirror
Finish: Chrome (CHR)
Packed: 12 per carton with screws



268 CHR Heavy-Duty Cast Mirror Clip

Size: 1-1/4" long x 11/16" wide, for 1/4" thick glass/mirror
Finish: Chrome (CHR)
Packed: 12 per carton with screws



277 ANO Bottom-Mount Steel Mirror Clip

Size: 1-1/2" wide x 1" high, for 1/4" thick glass/mirror
Finish: Anochrome (ANO)
Origin: Made in the USA
Packed: 10 per carton
Features: Screw attached bottom flange for snug mounting



278 ANO Top-Mount Steel Mirror Clip

Size: 1-1/2" wide x 1-1/8" high, for 1/4" thick glass/mirror
Finish: Anochrome (ANO)
Origin: Made in the USA
Packed: 10 per carton
Features: Screw attached upper flange for snug mounting



288 ANO Steel Mirror Clip

Size: 1/2" wide, for 1/4" thick glass/mirror
Finish: Anochrome (ANO)
Origin: Made in the USA
Packed: 100 per carton



309 ANO Steel Mirror Clip

Size: 9/16" wide x 1-1/4" long, for 5/16" thick glass/mirror
Finish: Anochrome (ANO)
Origin: Made in the USA
Packed: 100 per carton
Features: Countersunk for #4 screws



313 ANO 1/2 and 313 ANO 3/4 Steel Mirror Clips

Size: 9/16" wide
 313 ANO 1/2 for 1/2" thick glass/mirror
 313 ANO 3/4 for 3/4" thick glass/mirror
Finish: Anochrome (ANO)
Origin: Made in the USA
Packed: 100 per carton



313 Series Steel Mirror Clips

Product	Finish
313 ANO 1/2	Anochrome
313 ANO 3/4	Anochrome

318 ANO Steel Mirror Clip

Size: 9/16" wide x 1-1/4" long, for 5/16" thick glass/mirror
Finish: Anochrome (ANO)
Origin: Made in the USA
Packed: 100 per carton
Features: Countersunk elongated slot for #5 flat head screws; elongated mounting hole for adjustable installation



537 ZC Steel Hanger

Size: 1-13/16" tall x 5/8" wide
Finish: Zinc (ZC) plated steel
Origin: Made in the USA
Packed: 100 per carton
Features: Two 3/16" screw holes, one keyhole



Fittings

306 ANO Glass Fitting

Size: 9/16" wide x 1-1/4" long
Finish: Anochrome (ANO)
Packed: 100 per carton
Origin: Made in the USA
Features: Countersunk for #4 screws



Latches

989 Series Secret Gate Latch

Size: 2" x 2-3/8"
Finish: Brass-look, Aluminum
Packed: 12 per carton
Features: Interchangeable left or right hand mounting



989 Series Secret Gate Latch

Product	Finish
989 SPR BR	Brass-look
989 ALUM	Aluminum

☐ Non-stock item – minimum order quantities and additional lead time may apply.

Index Followers, Label Holders, Locks and Pulls



Index Followers and Track

475F ZC Card Sized Index Follower

Size: Mounted plate is 2-11/16" from track and 4-3/4" wide
Finish: Anochrome (ANO)
Origin: Made in the USA
Packed: 10 per carton



476F ZC Letter Sized Index Follower

Size: Mounted plate is 7-5/8" from track and 10-3/4" wide
Finish: Anochrome (ANO)
Origin: Made in the USA
Packed: 10 per carton



476T ZC 26 Index Follower Track

Size: 26" long; may be recessed in a 2-1/4" x 1/4" slot
Finish: Anochrome (ANO)
Origin: Made in the USA
Packed: 10 per carton with screws



Label Holders

701 ANO Label Holder

Size: 2-5/8" x 1-7/16" for card dimension of 2" x 1"
Finish: Anochrome (ANO)
Origin: Made in the USA
Packed: 100 per carton



704 ANO Label Holder

Size: 3-1/2" x 1-3/4" for card dimension of 2-15/16" x 1-1/2"
Finish: Anochrome (ANO)
Origin: Made in the USA
Packed: 100 per carton



Drawer Locks

986 Series Drawer Lock

Size: Mounting flange: 1-1/2" x 2" wide with screw holes on 1-7/16" centers; barrel OD: 7/8"; bolt travel: 3/8"
Finish: Polished Nickel (NP)
Origin: Made in the USA
Packed: 12 per carton
Features: Available keyed alike; mounts to material up to 7/8" thick



986 Series Drawer Locks

Product	Finish	Keyed
986KA 70 NP	Nickel (NP)	Alike

Drawer Pulls

819X Flush Drawer Pull

Size: 1-3/4" x 3-1/4" x 9/16" deep with beveled edges
Finish: Anochrome (ANO), Dull Brass (BR), Polished Brass (PB)
Packed: 12 per carton with screws



819X Flush Drawer Pull

Product	Finish
819X ANO	Anochrome (ANO)
819X BR	Dull Brass (BR)
819X PB	Polished Brass (PB)

822 ALUM Extruded Aluminum Pull

Size: 3-7/8" long
Finish: Aluminum (ALUM)
Packed: 12 per carton



Fasteners and Hinges

Surface Fasteners

320 STL Table Top Fastener, 1" width
 323 STL Table Top Fastener, 5/8" width
 324 STL Table Top Fastener, 3/4" width
Finish: Steel (STL)
Origin: Made in the USA
Packed: 100 per carton



341 ZC and 342 ZC Corner Brace
Size: 341: 1" x 1" installed
 342: 2" x 2" installed
Finish: Zinc (ZC)
Origin: Made in the USA
Packed: 100 per carton



1547 STL Desk Top Fastener
Finish: Steel (STL)
Origin: Made in the USA
Packed: 100 per carton



1548 ZC Desk Top Fastener
Finish: Zinc (ZC)
Origin: Made in the USA
Packed: 500 per carton



521 ZC Hanger Plate (1/16" steel)
Size: 13/16" x 2"
Finish: Zinc (ZC)
Origin: Made in the USA
Packed: 100 per carton
Features: Use with 3/4" #10 flathead wood screws



Bolt Style Fastener

510 ZC Joint Fastener
Size: 4" bolt with plate 5/16" x 5/8" x 1-1/2"
Finish: Zinc (ZC)
Packed: 100 per carton
Features: An economical fastener, easy to install



513 ZC Joint Fastener
Size: 4" bolt with flat bar plate
 7/16" x 3/16" x 1-1/4"
Finish: Zinc (ZC)
Packed: 100 per carton



517 ZC Joint Fastener
Size: 3-1/2" bolt with flat bar plate 7/16" x 3/16" x 1-1/4"
Finish: Zinc (ZC)
Packed: 100 per carton



Tite-Joint® Fastener

516 ZC designed for 3/4" wood
Size: Center-to-center 2" to 3-1/2"
Finish: Zinc (ZC)
Origin: Made in the USA
Features: Applies an even, controlled pressure between joint members to eliminate twisting and buckling

Pack Configurations		
Standard	25 per carton	
Builders (BP)	100 per carton	
516 Fasteners Zinc (ZC)		
Standard	Builders (BP)	
516/25 ZC	516/100 ZC	
516 Joint Fastener Accessory Parts		
Product	Description	Packed
516-1	Draw Bolt	1 per carton
516-60	Locking Sleeve	1 per carton
516-62	Tightening Rod	1 per carton
516-63	Drill Guide	1 per carton
516-64	Drill	1 per carton
516-80 100	Tightening Assembly	1 per carton

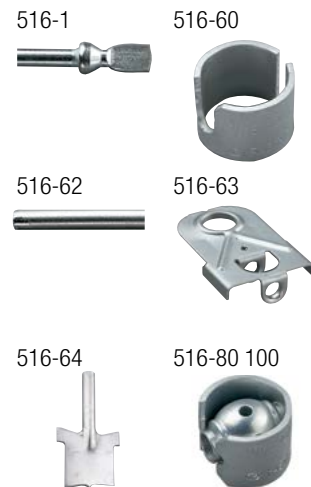

Hinges

472 ANO Steel Support Hinge
Size: 6" or 10"
Finish: Anochrome (ANO)
Origin: Made in the USA



Pack Configurations				
Standard	12 pair (left and right handed) per carton with screws			
Optional	Left or right hand packaged separately in cartons of 24			
472 Support Hinges Standard Pack				
Standard	Finish	Product	Finish	Handed
472 ANO 6	Anochrome (ANO)	472L ANO 6	Anochrome (ANO)	Left
472 ANO 10	Anochrome (ANO)	472L ANO 10	Anochrome (ANO)	Left
		472R ANO 6	Anochrome (ANO)	Right
		472R ANO 10	Anochrome (ANO)	Right

Locks and Door Rollers

Sliding Glass Door Locks

962KA 440 CHR Adjustable Ratchet Lock for 3/4" glass

963KA 440 CHR Adjustable Ratchet Lock for 1/4" glass*

Size: Adjustable 3/4" to 3-3/8"

Finish: Chrome (CHR)

Packed: 12 per carton

Features: 962 fits any door to 3/4" with thumbscrew adjustment
963 fits 1/4" sliding glass doors, keyed alike



965 Ratchet Locks

Size: Adjustable from 1" to 3-3/8"

Finish: Polished Nickel (NP)

Packed: 12 per carton

Features: Adjustable lock for 1/4" sliding glass doors

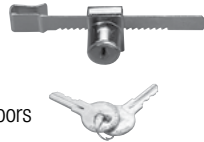

965 Ratchet Locks

Product	Finish	Keyed
965KA 50 NP	Polished Nickel	Alike

984KA 90 NP Plunger Lock

Size: Mounting flange: 7/8" x 2" with screw holes on 1-1/2" centers; Barrel: 7/8" outside diameter; Plunger travel: 15/32"; Plunger receptacle: 1/2" (outside diameter) x 7/16"

Finish: Polished Nickel (NP)

Packed: 12 per carton

Features: Keyed alike only



Door Rollers

420 STL Door Roller

Size: Frame: 7/16" x 1-7/8";

Nylon roller: 9/16" diameter; 5/16" wide

Finish: Steel (STL)

Packed: 100 per carton



422 STL Door Roller

Size: Frame: 5/8" x 1-13/16";

Nylon roller: 9/16" diameter; 1/2" wide

Finish: Steel (STL)

Packed: 100 per carton



423 STL Door Roller

Size: Frame: 5/8" x 1-13/16";

Steel roller: 5/8" diameter; 1/2" wide

Finish: Steel (STL)

Packed: 100 per carton

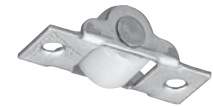

424 STL Door Roller

Size: Frame: 1" x 2";

Steel roller: 5/8" diameter; 7/8" wide

Finish: Steel (STL)

Packed: 50 per carton



Sheaves

413X BR Brass Sheave

Size: Frame: 2-15/16" x 7/16"; Wheel: 1-3/16" diameter
Finish: Bronze wheel with a Brass-look (BR) frame
Packed: 50 per carton with screws
Features: Brass wheel on self-lubricating bearing; for use with KV tracks 455, 467, and 469



607 ZC Side Mount Steel Sheave

Size: Frame: 2-5/16" x 1-5/16"; Wheel: 1-3/8" diameter
Finish: Steel (STL)
Packed: 50 per carton
Features: Heavy-duty ball-bearing sheave with side fastening plate; for use with KV tracks 455, 467, and 469



427 STL Steel Sheave

Size: Frame: 2-15/16" x 1/2"; Wheel: 1-3/16" diameter
Finish: Steel (STL)
Packed: 50 per carton
Features: Ball-bearing round groove sheave; for use with KV tracks 455, 467, and 469



620 STL Steel Sheave

Size: Frame: 7/16" x 1-7/8"; Wheel: 11/16" x 9/32"
Finish: Steel (STL)
Packed: 100 per carton
Features: Axle bearing grooved steel roller; for use with KV tracks 455, 467, and 469



429 STL Steel Sheave

Size: Frame: 2-1/4" x 3/8"; Wheel: 1" diameter
Finish: Steel (STL)
Packed: 100 per carton
Features: Round groove sheave; for use with KV tracks 455, 467, and 469



400A STL Concealed Steel Sheave

Size: Case: 1-1/4" x 5/16"; Flange: 1-3/4" x 9/16"
Finish: Steel (STL)
Packed: 100 per carton
Features: Ball-bearing sheave drive type; for use with KV tracks 455, 467, and 469



430 STL Steel Sheave

Size: Frame: 2-3/4" x 1/2"; Wheel: 1-3/8" diameter
Origin: Made in the USA
Finish: Steel (STL)
Packed: 50 per carton
Features: Ball-bearing round groove sheave; for use with KV tracks 455, 467, and 469



402 STL Concealed Steel Sheave

Size: Frame: 1-1/4" x 5/16"; Flange: 2-1/4" x 5/16"
Finish: Steel (STL)
Packed: 100 per carton
Features: Ball-bearing sheave; for use with KV tracks 455, 467, and 469



430 N STL Neoprene Treaded Steel Sheave

Size: Frame: 2-3/4" x 1/2"; Wheel: 1-3/8" diameter
Finish: Steel (STL)
Packed: 50 per carton
Features: Flat neoprene tire, ball-bearing sheave; used without track



580 STL Concealed Steel Sheave

Size: Case: 1-1/4" x 5/16"; Flange: 1-3/4" x 9/16"
Finish: Steel (STL)
Packed: 100 per carton
Features: Nylon round groove sheave for light doors; for use with KV tracks 455, 467, and 469



592 STL Convex Nylon Sheave

Size: Frame: 9/32" x 2-1/4"; Wheel: 1-3/16" diameter
Finish: Steel (STL)
Packed: 100 per carton
Features: Convex nylon wheel for thin doors; for use with inverted KV track 455



582 STL Concealed Steel Sheave

Size: Case: 1-1/4" x 5/16"; Flange: 2-1/4" x 5/16"
Finish: Steel (STL)
Packed: 100 per carton
Features: Nylon round groove sheave; for use with KV tracks 455, 467, and 469



594 NYLON Concave Nylon Sheave

Size: Frame: 2-15/16" x 1/2"; Wheel: 1-3/16" diameter
Finish: Steel (STL)
Packed: 50 per carton
Features: For doors to 1-1/8" thick; nylon round groove wheel; for use with all KV tracks



Fiber Track and Guides for Sliding Doors

Fiber Track

2401 FIBRE 72

2401

Size: 1/8" width x 1/2" height x 72" length

Finish: Black

Packed: 1 each

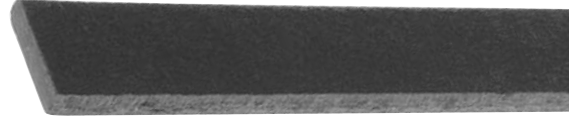

Nylon Guides

2406 Nylon Guide

2406

Size: 1" length x 1/4" width

Packed: 50 per carton



2407 Nylon Guide

2407

Size: 1-3/8" length x 3/8" width

Packed: 50 per carton



Plastic Tracks and Guides for Sliding Doors

Plastic Track and Upper Guides for 1/4" Doors

2412 Series Upper Guides*

Size: 27/32" width x 9/16" height x 144" length

Finish: Tan (TAN), Gray (GRY), and Walnut (WAL)

Packed: 1 each

2412 Series Upper Guides	
Product	Finish
2412 GRAY 144	Gray (GRY)
2412 TAN 144	Tan (TAN)
2412 WAL 144	Walnut (WAL)

2416 Series Lower Tracks*

Size: 27/32" width x 5/16" height x 144" length

Finish: Tan (TAN), Gray (GRY), and Walnut (WAL)

Packed: 1 each

2416 Series Tracks	
Product	Finish
2416 GRAY 144	Gray (GRY)
2416 TAN 144	Tan (TAN)
2416 WAL 144	Walnut (WAL)

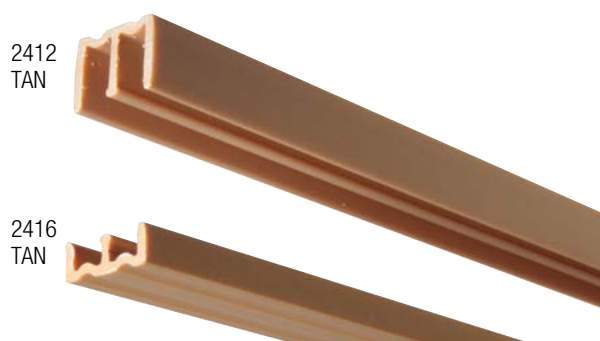

Plastic Track and Upper Guides for 3/4" Doors

2418 TAN 144 Upper Guide

Size: 1-15/16" width x 3/4" height x 144" length

Finish: Tan (TAN)

Packed: 1 each

2420 TAN 144 Lower Track

Size: 1-15/16" width x 3/8" height x 144" length

Finish: Tan (TAN)

Packed: 1 each

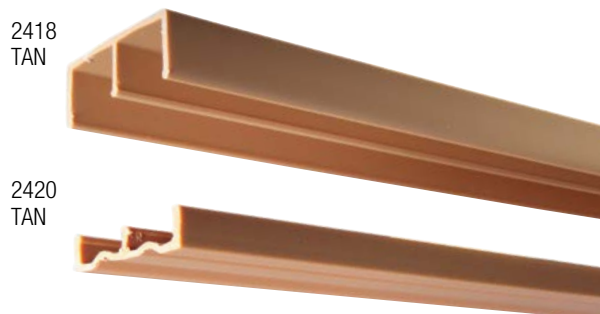

Plastic Door Track Assemblies for Sliding Doors

P2413 1/8" Door Assembly Kits

Size: 48", 60" and 72" lengths
Finish: Tan (TAN), White (WH)
Packed: 10 kits per carton

P2413
TAN

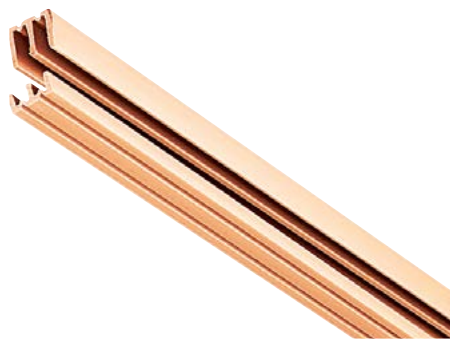

P2413 1/8" Door Assembly Kits			
Product	Finish	Length	Door Size
P2413 TAN 48	Tan (TAN)	48"	1/8"
P2413 TAN 60	Tan (TAN)	60"	1/8"
P2413 TAN 72	Tan (TAN)	72"	1/8"
P2413 WH 48	White (WH)	48"	1/8"
P2413 WH 60	White (WH)	60"	1/8"
P2413 WH 72	White (WH)	72"	1/8"

P2417 1/4" Door Assembly Kits

Size: 48", 60" and 72" lengths
Finish: Tan (TAN), Walnut (WAL), White (WH)
Packed: 10 kits per carton

P2417
TAN



P2417 1/4" Door Assembly Kits			
Product	Finish	Length	Door Size
P2417 TAN 48	Tan (TAN)	48"	1/4"
P2417 TAN 60	Tan (TAN)	60"	1/4"
P2417 TAN 72	Tan (TAN)	72"	1/4"
P2417 WAL 48	Walnut (WAL)	48"	1/4"
P2417 WAL 60	Walnut (WAL)	60"	1/4"
P2417 WAL 72	Walnut (WAL)	72"	1/4"
P2417 WH 48	White (WH)	48"	1/4"
P2417 WH 60	White (WH)	60"	1/4"
P2417 WH 72	White (WH)	72"	1/4"

P2419 3/4" Door Assembly Kits

Size: 48", 60" and 72" lengths
Finish: Tan (TAN), White (WH)
Packed: 10 kits per carton

P2419
TAN

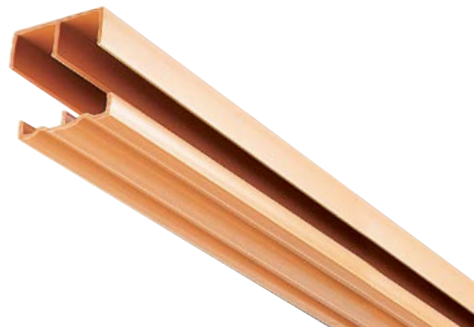

P2419 3/4" Door Assembly Kits			
Product	Finish	Length	Door Size
P2419 TAN 48	Tan (TAN)	48"	3/4"
P2419 TAN 60	Tan (TAN)	60"	3/4"
P2419 TAN 72	Tan (TAN)	72"	3/4"
P2419 WH 48	White (WH)	48"	3/4"
P2419 WH 60	White (WH)	60"	3/4"
P2419 WH 72	White (WH)	72"	3/4"

P2421 1/2" Door Assembly Kits

Size: 48", 60" and 72" lengths
Finish: Tan (TAN), White (WH)
Packed: 10 kits per carton

P2421
TAN



P2421 1/2" Door Assembly Kits			
Product	Finish	Length	Door Size
P2421 TAN 48	Tan (TAN)	48"	1/2"
P2421 TAN 60	Tan (TAN)	60"	1/2"
P2421 TAN 72	Tan (TAN)	72"	1/2"
P2421 WH 48	White (WH)	48"	1/2"
P2421 WH 60	White (WH)	60"	1/2"
P2421 WH 72	White (WH)	72"	1/2"

Finish:



Tan
(TAN)



Walnut
(WAL)



White
(WH)

☐ Non-stock item – minimum order quantities and additional lead time may apply.

Steel Tracks and Guides for Sliding Doors

455 STL 144 Lower Track

Size: 19/64" height x 21/32" width x 144" length
Finish: Wrought Steel (STL)
Origin: Made in the USA
Packed: 1 each
Features: 1/2" nails included



455 STL

455 SS 144 Lower Track

Size: 19/64" height x 21/32" width x 144" length
Finish: Stainless Steel (SS)
Origin: Made in the USA
Packed: 1 each
Features: 1/2" nails included



455 SS

467 STL 144 Lower Track

Size: 19/64" height x 7/16" width x 144" length
Finish: Steel (STL)
Origin: Made in the USA
Packed: 1 each
Features: 1/2" nails included



467

469 Series Double Lower Track

Size: Double track 1/4" height
Finish: Zinc (ZC)
Origin: Made in the USA
Packed: 1 each
Features: 1/2" #5 flat head wood nails included



469

469 Series Double Lower Track

Product	Length
469 ZC 72	72"
469 ZC 96	96"
469 ZC 144	144"

953 ZC 144 Top Door Divider

Size: 5/8" height x 5/8" width x 144" length
Finish: Pre-coated Steel (ZC)
Origin: Made in the USA
Packed: 1 each
Features: Upper T-guide separates the sliding door at the top



953

Roll-Ezy Ball-Bearing Track Systems



Complete Assembly

P992 Large Glass Door Track Assembly Kit

Includes: (1) 993 Upper Channel, (2) 995 Shoe, (2) 997 Carrier, (1) 999 Lower Track

Origin: Made in the USA

Packed: 1 set per carton

Features: For large glass door applications, for 1/4" thick glass installations

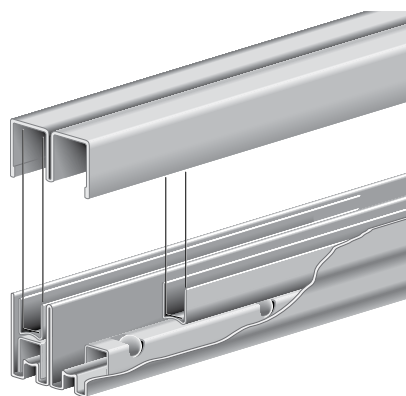

Complete Assemblies	
Product	Installation Opening Width
P992 ZC 36	36"
P992 ZC 48	48"
P992 ZC 60	60"
P992 ZC 72	72"

Installation Notes & Recommendations:
 Knape & Vogt does not recommend butt-joints and/or openings longer than 12 feet.
 We recommend that the height to width ratio for glass doors should not exceed 2:1.

953 ZC 144 Top Door Divider

Size: 5/8" width x 5/8" height x 144" length

Finish: Zinc (ZC)

Origin: Made in the USA

Packed: 1 each

Features: Pre-coated steel upper T-guide for wood framed installations; for use with 1/4" glass doors only; for large glass door applications



993 ZC 144 Upper Channel

Size: 15/16" wide x 5/8" height x 144" length

Finish: Zinc (ZC)

Origin: Made in the USA

Packed: 1 each

Features: Upper channel for top and ends of opening; wide divider maintains door position; for large glass door applications

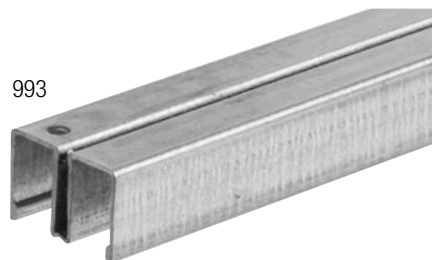

995 ZC 144 Door Shoe

Size: 21/64" wide x 7/16" height x 144" length

Finish: Zinc (ZC)

Origin: Made in the USA

Packed: 1 each

Features: Lightly curved bottom for free rolling position on ball-bearings; for 1/4" glass, scant or full; for large glass door applications



997 ZC 144 Ball Carrier

Size: 3/8" wide x 17/32" height x 144" length

Finish: Zinc (ZC)

Origin: Made in the USA

Packed: 1 each

Features: Ball-bearing carrier has free rolling balls on 3" centers; unique design creates two point suspension between shoe and lower rack; for large glass door applications



999 ZC 144 Lower Track

Size: 1" wide x 1" high x 144" length

Finish: Zinc (ZC)

Origin: Made in the USA

Packed: 1 each

Features: Balls ride freely on curved anvil with no contact against sides of lower track; for large glass door applications



NOTE: For each foot of opening use 1' of upper channel and lower track and shoe (plus 1" per door for overlap), with 1-1/2' of carrier (1-1/2 times door width for each door). Glass is cut 1-1/4" lower than height of opening.

Roll-Ezy Aluminum Track Systems

Complete Assembly



P1092 Small to Medium Glass Door Track Assembly Kit

Includes: (1) 1093 Upper Channel, (4) 1097 Rollers,
(4) 1085 Vinyl Guides, (2) 1095 Shoe, (1) 1099 Lower Track

Packed: 1 set per carton

Features: For small to medium size glass door installations;
for 1/4" thick glass

Complete Assemblies	
Product	Length
P1092 ANOD 36	36"
P1092 ANOD 48	48"
P1092 ANOD 60	60"
P1092 ANOD 72	72"

Installation Notes & Recommendations:
Knape & Vogt does not recommend butt-joints
and/or openings longer than 12 feet.
We recommend that the height to width ratio for
glass doors should not exceed 2:1.



1093 144 Upper Channel

Size: 1-3/16" width x 9/16" height x 144" length

Finish: Aluminum (AL)

Origin: Made in the USA

Packed: 1 each

Features: Double channel for tops, bottoms, and ends; for small to
medium size glass door installations; for 1/4" thick glass

1093

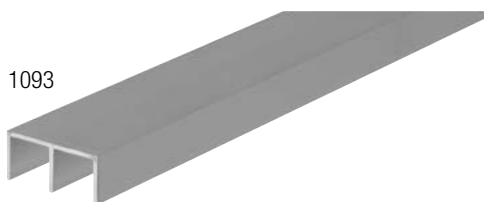

1095 144 Door Shoe

Size: 27/64" width x 1" height x 144" length

Finish: Aluminum (AL)

Origin: Made in the USA

Packed: 1 each

Features: Rollers to be inserted in the bottom; for small to medium
size glass door installations; for 1/4" thick glass

1095

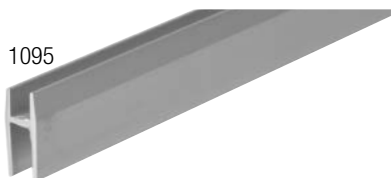

1096 144 Single Lower Track

Size: 31/64" width x 15/32" height x 144" length

Finish: Aluminum (AL)

Origin: Made in the USA

Packed: 1 each

Features: For single doors, or may be used with 1093 double channel
for covered installation; for small to medium size glass door
installations; for 1/4" thick glass

1096



NOTE: Cut glass 1-1/2" lower than opening when using 1096/1093 tracks

1099 144 Double Lower Track

Size: 1-1/16" width x 1/4" height x 144" length

Finish: Aluminum (AL)

Origin: Made in the USA

Packed: 1 each

Features: For small to medium size glass door installations;
for 1/4" thick glass

1099

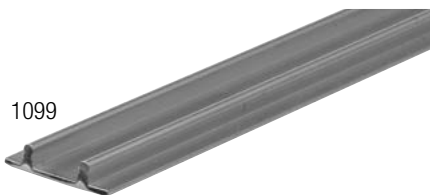

NOTE: Cut glass 1-3/16" lower than opening when using 1099 track

1085 VINYL Guide

Size: 7/8" length

Finish: Vinyl (VINYL)

Origin: Made in the USA

Packed: 100 per carton

Features: Vinyl guide fits over the top of glass for noiseless operation
in upper channel; for small to medium size glass door
installations; for 1/4" thick glass



1087 RUB Rubber Bumper

Finish: Rubber (RUB)

Packed: 100 per carton

Features: Rubber bumper installs in jambs to cushion glass



1097 NYLON Nylon Rollers

Finish: Nylon (NYLON)

Origin: Made in the USA

Packed: 100 per carton

Features: Rubber roller press fits into bottom of 1095 shoe



1098 ZC Steel Ball-bearing Roller

Finish: Zinc (ZC)

Origin: Made in the USA

Packed: 20 per carton

Features: Steel ball-bearing roller press fits into bottom
of 1095 shoe

